

# WORKSTEAD

brick

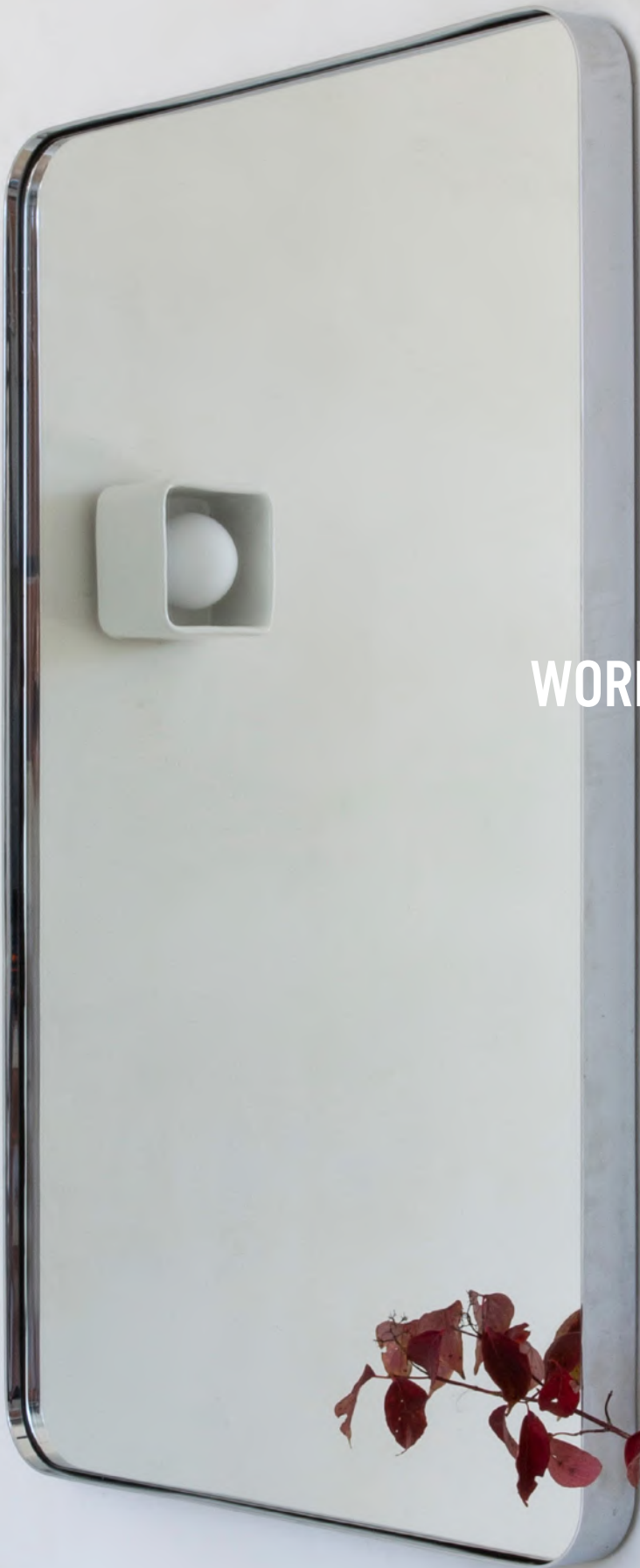

# WORKSTEAD



**BRICK I**  
glazed white

# WORKSTEAD

## BRICK I

hardwired

### Description

The BRICK I is a modern interpretation of the classic vanity light, celebrating the dialogue between the handmade and the serial. A cast earthenware base hand-glazed in soft white frames a matte opal globe, suggesting a hollowed brick cradling a neotenic form. The ADA compliant fixture can be used on both walls and ceilings, for a flattering luminous glow. UL Listed. Damp Rated.

### Body Finish

Glazed White

### Hardware Finish

White Enamel

### Dimensions

Overall Height - 5"  
Width - 5"  
Depth - 4"

### Weight

4 lbs

### Lamp

10 Watt LED Max  
2.5 Watt Dimmable  
Mini-Candelabra LED Included  
35 Watt Equivalent  
250 Lumens  
3000K Color Temperature  
Bulb Life 25,000 Hours  
90+ CRI  
110/120V, E12  
220/240V, E14  
UL/CE Listed  
Damp Rated

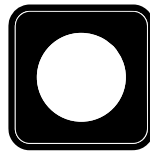
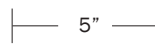

front

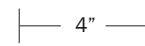

side

# WORKSTEAD

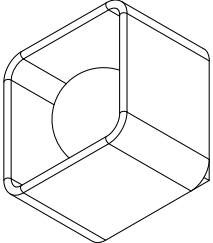
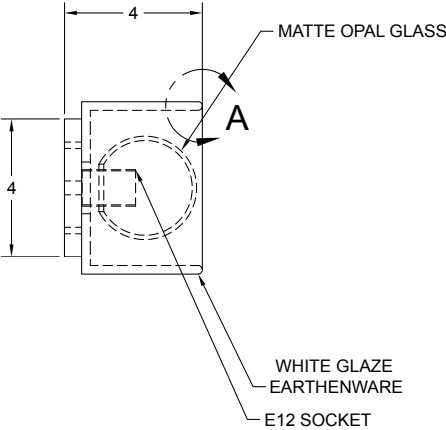
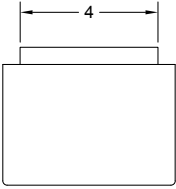
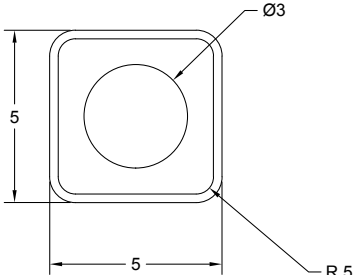

# WORKSTEAD



**BRICK III**  
glazed white

# WORKSTEAD

## BRICK III

hardwired

### Description

The BRICK III is a modern interpretation of the classic vanity sconce, celebrating the dialogue between the handmade and the serial. A cast earthenware base hand-glazed in soft white frames a trio of matte opal globes, suggesting a hollowed brick cradling neotenic forms. The ADA compliant sconce can be mounted vertically or horizontally for a flattering, luminous glow. UL Listed. Damp Rated.

### Body Finish

Glazed White

### Hardware Finish

White Enamel

### Dimensions

Overall Height - 15"  
Width - 5"  
Depth - 4"

### Weight

10 lbs

### Lamp

10 Watt LED Max  
2.5 Watt Dimmable  
Mini-Candelabra LED Included  
35 Watt Equivalent  
750 Lumens  
3000K Color Temperature  
Bulb Life 25,000 Hours  
90+ CRI  
110/120V, E12  
220/240V, E14  
UL/CE Listed  
Damp Rated

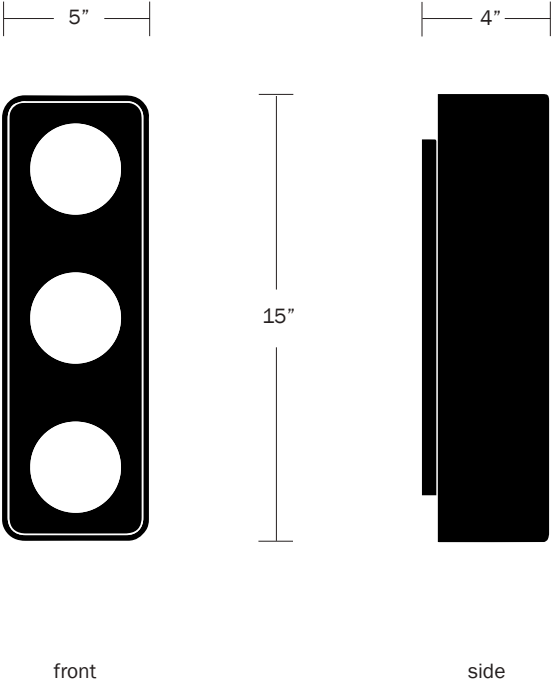

# WORKSTEAD

