

BEAM 02 PENDANT

Collection:

Beam and Glow

Design Year:

2018

Dimensions:

W 8.5in/21cm x D 4in/10cm x H 26in/66cm

LED Illumination:

Wattage: 24.82

Lumens: 1604.8

Color Temperature: 2400K

Life Hours: 50,000

CRI: 95

Local TRIAC Dimmable Driver (120V)

Remote 0-10V Dimmable Driver (240V)

Materials:

Aluminum, integrated LED, Chromatic Resin Lens

Metal Finish Options:

Anodized: Silver, Black

Hand-Stained: Lilac, Green

Please inquire for custom anodized/hand-stained colors.

Lens Color:

Amber, Rose, Frosted

Mounting:

Ceiling Pendant. Fixed pipe suspension: Overall height to be specified at time of order. 5in/12.7cm square canopy in matching metal finish.

Certification:

UL, cUL, CE

Made in:

New York, USA

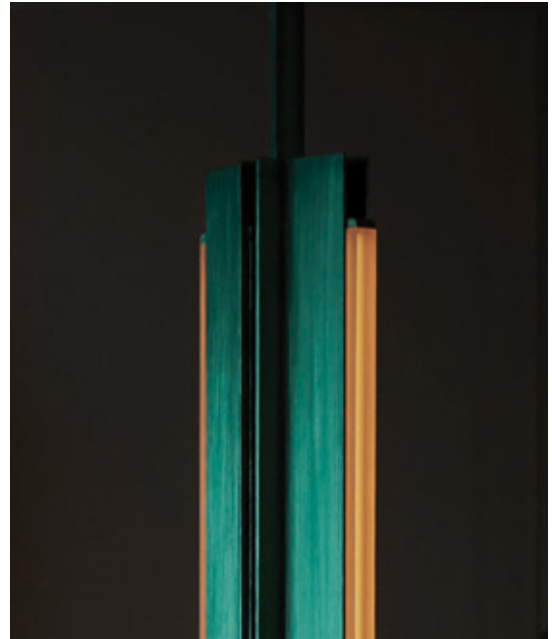

Pictured in Hand-Stained Green with Amber Lens

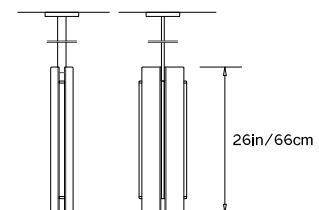
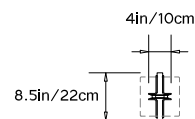

BEAM 04 PENDANT

Collection:

Beam and Glow

Design Year:

2018

Dimensions:

W 8.5in/21cm x D 4in/10cm x H 47.75in/120cm

Weight:

25lbs/11kg

LED Illumination:

Wattage: 51.1

Lumens: 3304

Color Temperature: 2400K

Life Hours: 50,000

CRI: 95

Local TRIAC Dimmable Driver (120V)

Remote 0-10V Dimmable Driver (240V)

Materials:

Aluminum, integrated LED, Chromatic Resin Lens

Metal Finish Options:

Anodized: Silver, Black

Hand-Stained: Lilac, Green

Please inquire for custom anodized/hand-stained colors.

Lens Color:

Amber, Rose, Frosted

Mounting:

Ceiling Pendant. Fixed pipe suspension: Overall height to be specified at time of order. 5in/12.7cm square canopy in matching metal finish.

Certification:

UL, cUL, CE

Made in:

New York, USA

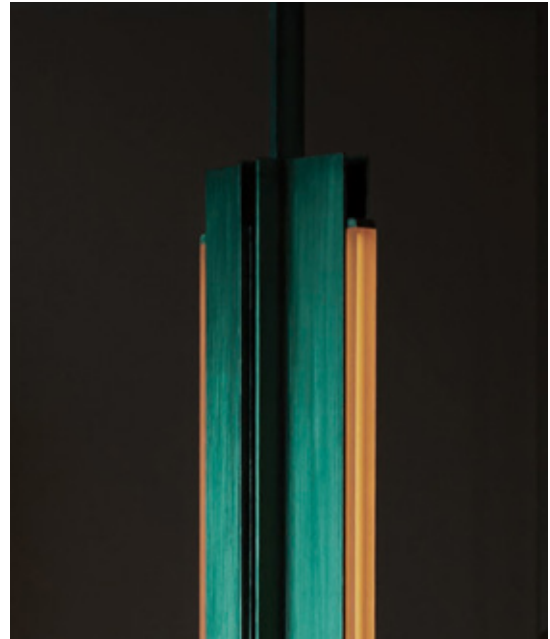

Pictured in Hand-Stained Green with Amber Lens

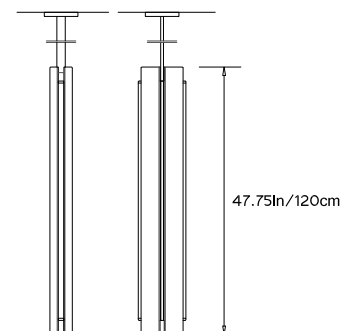
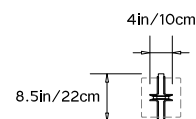

BEAM 06 PENDANT

Collection:

Beam and Glow

Design Year:

2018

Dimensions:

W 8.5in/21cm x D 4in/10cm x H 69.25in/176cm

LED Illumination:

Wattage: 75.92

Lumens: 4908.8

Color Temperature: 2400K

Life Hours: 50,000

CRI: 95

Local TRIAC Dimmable Driver (120V)

Remote 0-10V Dimmable Driver (240V)

Materials:

Aluminum, integrated LED, Chromatic Resin Lens

Metal Finish Options:

Anodized: Silver, Black

Hand-Stained: Lilac, Green

Please inquire for custom anodized/hand-stained colors.

Lens Color:

Amber, Rose, Frosted

Mounting:

Ceiling Pendant. Fixed pipe suspension: Overall height to be specified at time of order. 5in/12.7cm square canopy in matching metal finish.

Certification:

UL, cUL, CE

Made in:

New York, USA

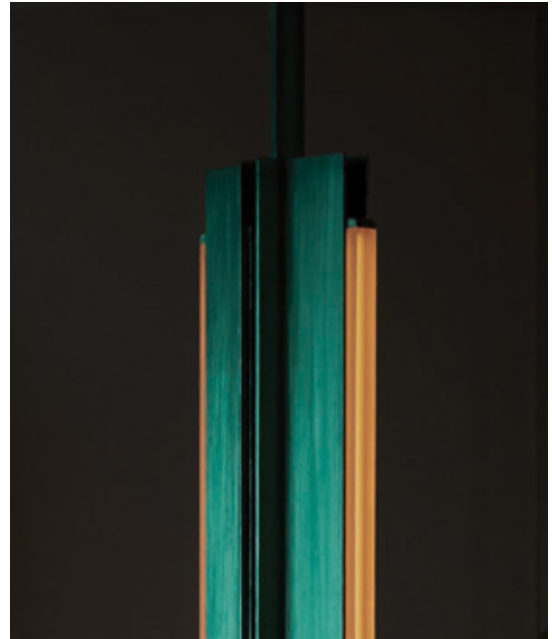

Pictured in Hand-Stained Green with Amber Lens

