



GABRIEL SCOTT

EST. 2012



MYRIAD

Wishbone Pendant

in Satin Bronze &
Alabaster White

The Myriad series is inspired by nature's bioluminescent organisms, this modular series is made up of the brand's signature double blown glass and satin metallic hardware. Its articulated stems carry the soft lit pivoting heads to create a delicate, asymmetric and ever changing silhouette.

These fine, jewel like fixtures are offered in assorted arrangements and available in various metal and glass finishes.

All Gabriel Scott pieces are handmade in Canada.

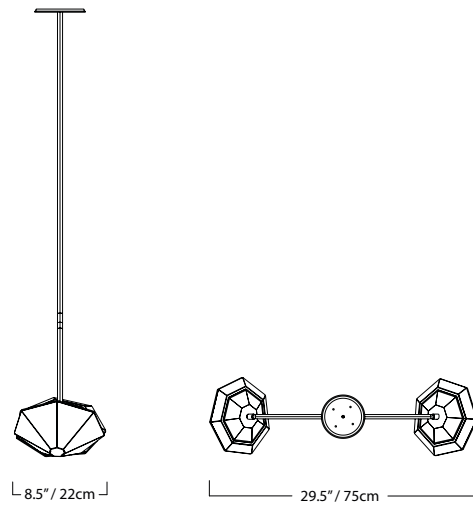
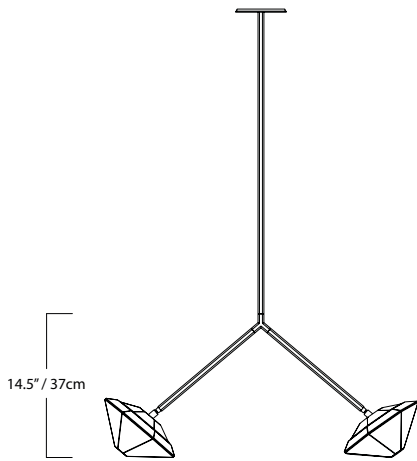

SPECIFICATIONS

Standard Finishes:

Blown Glass: Alabaster White

Metal: Blackened Steel, Satin Nickel, Satin Brass, Satin Copper or Satin Bronze

Specifications:

Dimensions: 29.5" x 8.5" x 14.5" H + Stem

75 cm x 22 cm x 37 cm H + Stem

Weight: 30 lbs / 13.6 kg

Light source: 12V 6 Watt LED (included)

LED Drivers: CCT13W500 - 120V
UVC25TD - 220V

Standard lead time: 12 - 14 weeks

Stems & Canopies:

Standard Stem Lengths: 6", 12", 18" or 24"

15 cm, 31 cm, 46 cm or 61 cm

Additional Stem Lengths: 30", 36", 42" or 48"

76 cm, 91 cm, 107 cm or 122 cm
(up-charge applies)

Standard Canopy: 5" x 0.5" / 12 cm x 1.3cm

Deep Canopy: Dimensions on request.

Custom finishes available upon inquiry.

Made and assembled in Canada. Item is UL & CE listed.

STANDARD FINISHES

Blown Glass:



Alabaster White

Metal:

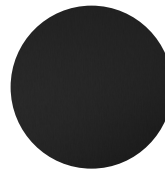

Blackened Steel

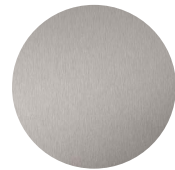

Satin Nickel



Satin Brass



Satin Copper



Satin Bronze

LED DRIVER

CCT13W500 - 120V

Magnitude's CCT Series dimmable Constant Current LED driver is class 2 rated and designed to operate with MLV, ELV and CL dimmer switches (forward phase/ reverse phase / TRIAC). The driver's low profile case allows OEM's to easily incorporate it into Luminaires. A 5-year warranty is a standard on all of Magnitude's products.

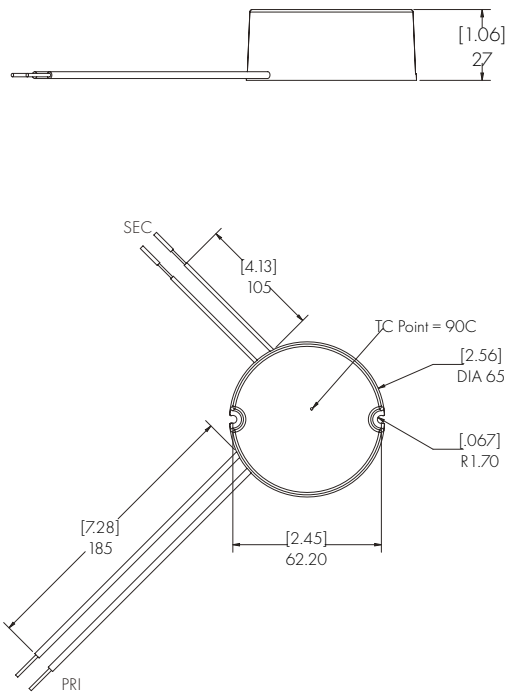

Features:

- Dimmable with MLV, ELV and CL dimmer switches (forward phase / reverse phase / TRIAC)
- Dim down to 5%
- Super compact case
- Class 2
- UL 8750
- Complies with FCC Part 15B
- Auto-Reset protection for short circuits, over-voltage and over-temperature

Specifications:

Input voltage	100 - 120VAC
Max output voltage	13W
Output voltage range	18 - 26 VDC
Output current range	500mA Nominal - 525 Max
Rated output power	9 - 13W
Efficiency at max load	> 82 %
THD at max load	< 20 %
Power factor at max load	> 0.9
Environment protection rating	IP21 - Dry and damp location
Tc case max	77c
Ambient op. temp.	-20c - 60c
Operating humidity	10% - 90%
Lifetime	50KHrs
Over voltage protection	Auto recovery
Open circuit protection	Max output voltage
Short circuit protection	Auto recovery
Surge protection	1KV
Weight	104g
Dimensions (inches)	2.56" D x 1.06" H
Dimensions (cm)	6.5 cm D x 2.7 cm H
Placement	Designed to fit in standard 4" junction box

LED DRIVER

UVC25TD - 220V

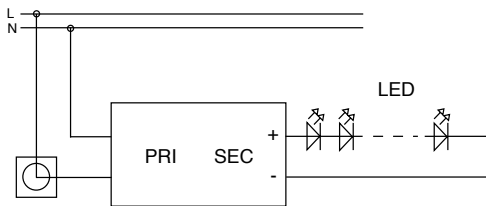
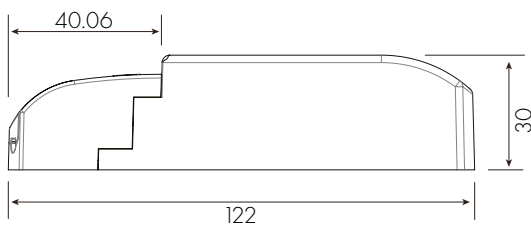
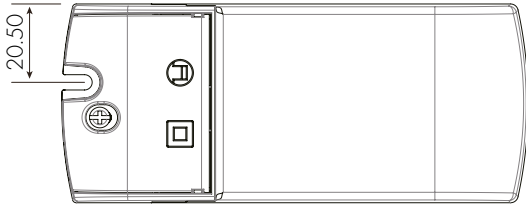

Features:

- Constant voltage output
- Fully isolated
- Short circuit, over current and over voltage protection up to 80% efficient
- Fire resistant plastic cover
- Compatible with leading and trailing edge dimmers
- 10 - 100% Dimming Load
- 10 - 100% Dimming range
- Mains dimmable
- Push terminals for easy installation
- IP44 design for indoor use
- 2 years warranty

Specifications:

Input Voltage	220V - 240VAC
Frequency	50-60 Hz
Current	0.2A
Inrush Current	<2.5A
Power Factor	0.95
Output Load Voltage	12V
No Load Voltage	12V
Current	2.08Av
Power	25W
Power Factor	> 0.95
Efficiency	80%
Over Load	Auto Recovery
Short Circuit	Auto Recovery
Over Voltage	Auto Recovery
Operating Temperature	-20 - +50°C
Storage Temperature	-40 - +70°C
Relative Humidity	5 - 95%
Safety Standard	Design refers to EN60598, EN61547, ENV55024, EN61000-4-2, 3, 4, 6, 8,11, EN61000-3-2, EN61000-3-3
EMI Standard	Meets Emissions to EN55022, EN55015 Class B
Lifetime	50K hrs at TC max (70c)
Weight	110g
Dimensions (inches)	4.8" x 2" x 1.2"
Dimensions (cm)	12.2 cm x 5.2 cm x 3 cm