



GABRIEL SCOTT

EST. 2012



1. Dorado Bead - Clear, Bubbled 2. Orion Bead - Opaque White, Twisted
3. Carina Bead - Opaque White, Twisted 4. Cygnus Bead - Opaque White, Twisted

LUNA Kaleido
XL 2 Tier
Chandelier

Inspired by a lunar halo, the Luna is a highly customizable modular light fixture which grows in every direction as its assembly system stems horizontally or vertically. Stacking color upon color of various mouth-blown glass shapes, the series has been designed to offer infinite interpretations of tone, shape and refracted light.

The new Kaleido Collection plays with texture, color and shape to distort light and create magical optical illusions when looking through the glass. Combining soft iridescent colors with patterned textures and delicately shaped glass beads, the Kaleido Collection effortlessly brings together smoked gray, smoked bronze, opaque pink, opaque blue, opaque white and clear colored glass with six new textures and shapes.

All Gabriel Scott pieces are handmade in Canada.

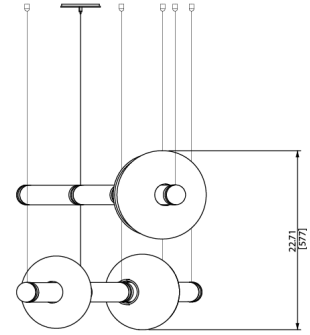
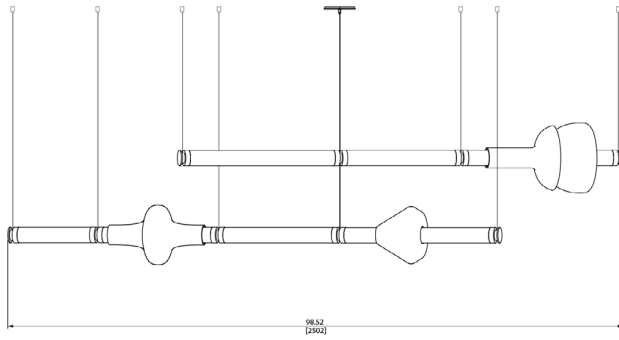

SPECIFICATIONS

Standard Finishes:

Metal: Blackened Steel, Satin Brass, Satin Copper, Satin Bronze or Satin Nickel

Glass Textures: Twisted, Bubbled, Ribbed, Gridded, Dotted or Smoothed

Glass Colours: Smoked Bronze, Smoked Gray, Clear, Opaque Blue, Opaque Pink or Opaque White

Specifications:

Dimensions: 98.52" x 22.71" + Drop

250 cm x 58 cm + Drop

Weight: 70 lbs / 31.7 kg

Light source: 24V 6 Watt LED (included)

LED Drivers: E96R24DC - 110V
UVC24100TD - 220V

Standard Lead time: 12 - 14 weeks

Cables & Canopies:

Cable Length: 96" / 244 cm Drop, adjustable upon installation

(increased cable-lengths available upon request)

Standard Canopy: 5" x 0.5" / 12 cm x 1.3 cm

Deep Canopy: Available upon request.

Custom finishes available upon inquiry.

Made and assembled in Canada. Item is UL & CE listed.



STANDARD FINISHES

Metal:

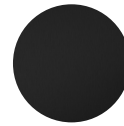

Blackened Steel



Satin Brass



Satin Copper



Satin Bronze



Satin Nickel

Glass Colors:



Smoked Bronze



Smoked Gray



Clear



Opaque Blue



Opaque Pink



Opaque White

Glass Textures:



Twisted

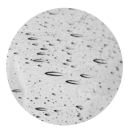

Bubbled

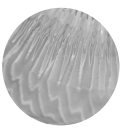

Ribbed

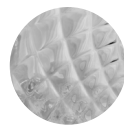

Gridded



Dotted



Smoothed

LUNA Kaleido XL 2 Tier A - With Dorado, Orion, Carina & Cygnus Glass Beads

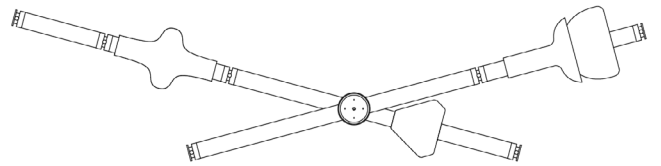
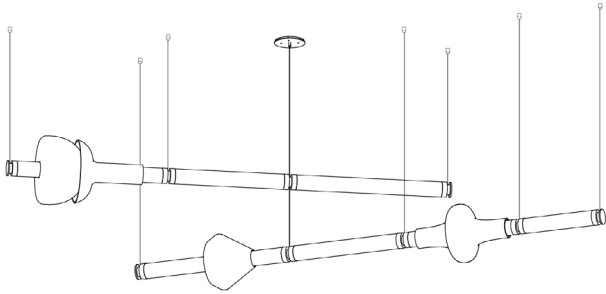

LUNA Kaleido XL 2 Tier B - With Orion, Lyra & Aras Glass Beads

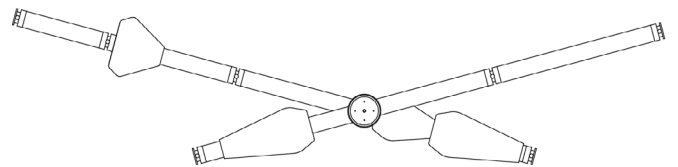
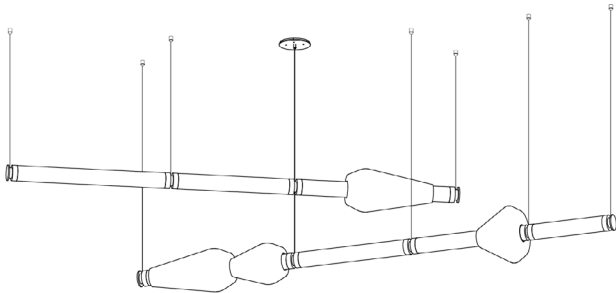
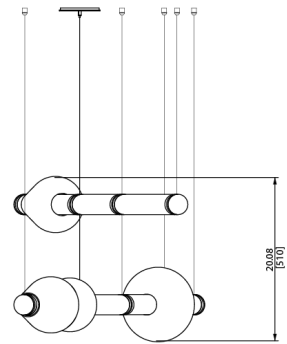
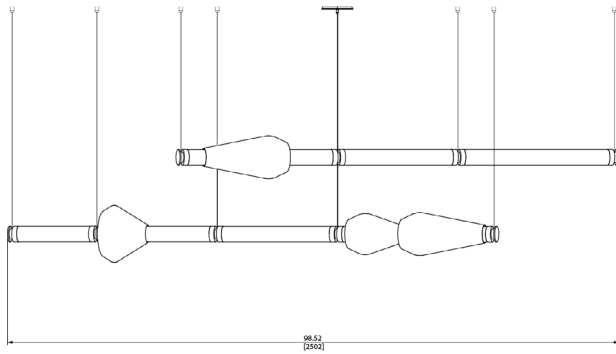

LUNA Kaleido - Finishes Selection

	 Twisted	 Bubbled	 Ribbed	 Gridded	 Dotted	 Smoothed
 Dorado 15.6" X DIA. 9.5"	  	  			 	 
 Lyra 13.9" X DIA. 6.9"	  	  	 	 		
 Aras 8.9" X DIA. 6.6"	  	  	 	 		
 Cygnus 7.6" X DIA. 11.2"	    	  				  
 Orion 7.5" X DIA. 9.2"	    	  	 			
 Carina 10.9" X DIA. 10.4"	 					 

Note: Every individual glass bead is hand-blown to order. With any artisanal process, there is likely to be variation in the finish which makes each piece unique and special. Every bead goes through a rigorous inspection process prior to being delivered to ensure they're up to the high standard Gabriel Scott expects.

LED DRIVER

E96R24DC - 110V

Magnitude's E96R24DC dimmable voltage LED driver is class 2 rated and designed to operate with any standard MLV/Incandescent TRIAC (Leading edge) dimmer switch. The driver's low profile aluminum case makes it the perfect choice for under cabinet lights, tape lights and various LED fixtures installations. Our electrical specification includes Auto Reset, over current and short circuit protection. Efficiency of 90% and higher allows the driver to operate at low temperatures.

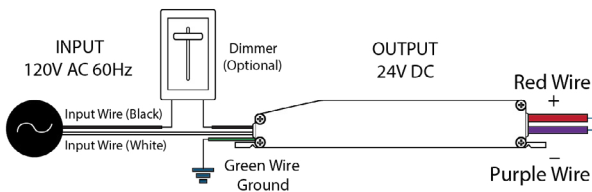
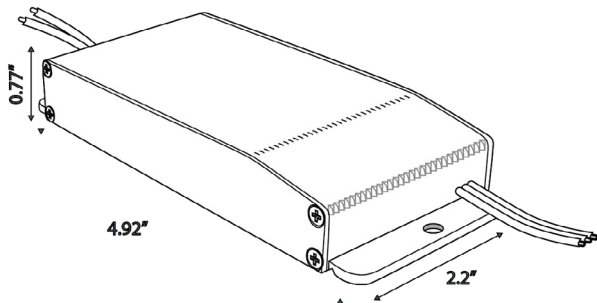

Features:

- Dimmable with any standard MLV/Incandescent
- TRIAC- (Leading edge) dimmer switch
- Dim down to 1%
- Super compact ALUMINUM CASE.
- Class 2
- UL 8750
- IP67 - Withstands wet and salty conditions.
- Auto-Reset Protection for short circuits & over-voltage.
- FCC 15 part 2

Specifications:

Max Load	96W
Input Voltage	120V AC
Input Current at Max Load	1 A
Output Voltage	24V DC
Output Current at Max load	4 A
Power Factor	0.95
Efficiency	> 90 %
Operating Temp.	-30c - 50c (-22F -122F)
Short Circuit Protection	Yes
Overcurrent Protection	Yes
Over Temperature	Yes
Open Circuit Protections	Yes
Input Wires (White / Black)	18 AWG
Output Wires (Red / Black)	14 AWG
Weight	255g
Dimensions (inches)	4.92" x 2.2" x 0.77"
Dimensions (cm)	12.5 cm x 5.6 cm x 2 cm

LED DRIVER

UVC24100TD - 220V

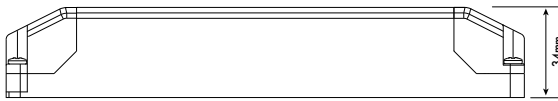
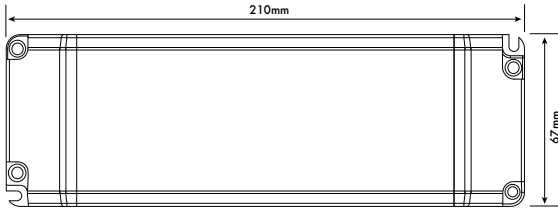

Features:

- Constant voltage output
- Fully isolated
- Short circuit, over current and over voltage protection up to 80% efficient.
- Fire resistant plastic cover
- Compatible with leading and trailing edge dimmers
- 34 - 100% Dimming Load
- 1 - 100% Dimming range
- Mains dimmable
- Screw terminals
- IP20 design for indoor use
- 2 years warranty

Specifications:

Part Code	UVC24100TD
Voltage	220V ~ 240VAC
Frequency	50-60 Hz
Current	0.6A
Inrush Current	<65A
Power Factor	0.95
Load Voltage	24V
No Load Voltage	24V
Current	1.4 - 4.2A
Power	34 -100W
Power Factor	>0.95
Efficiency (TYP.)	>89%
Over Load	Auto-recovery
Short Circuit	Auto-recovery
Over Voltage	Auto-recovery
Operating Temperature	-20 ~ +50°C
Storage Temperature	-40 ~ +70°C
Relative Humidity	5 ~ 95%
Lifetime	50K hrs at TC max (85°C)
Connections	Screw terminal on I/P & O/P
Weight	360g
Dimensions (inches)	8.3" x 2.6" x 1.3"
Dimensions (cm)	21 cm x 6.7 cm x 3.4 cm