

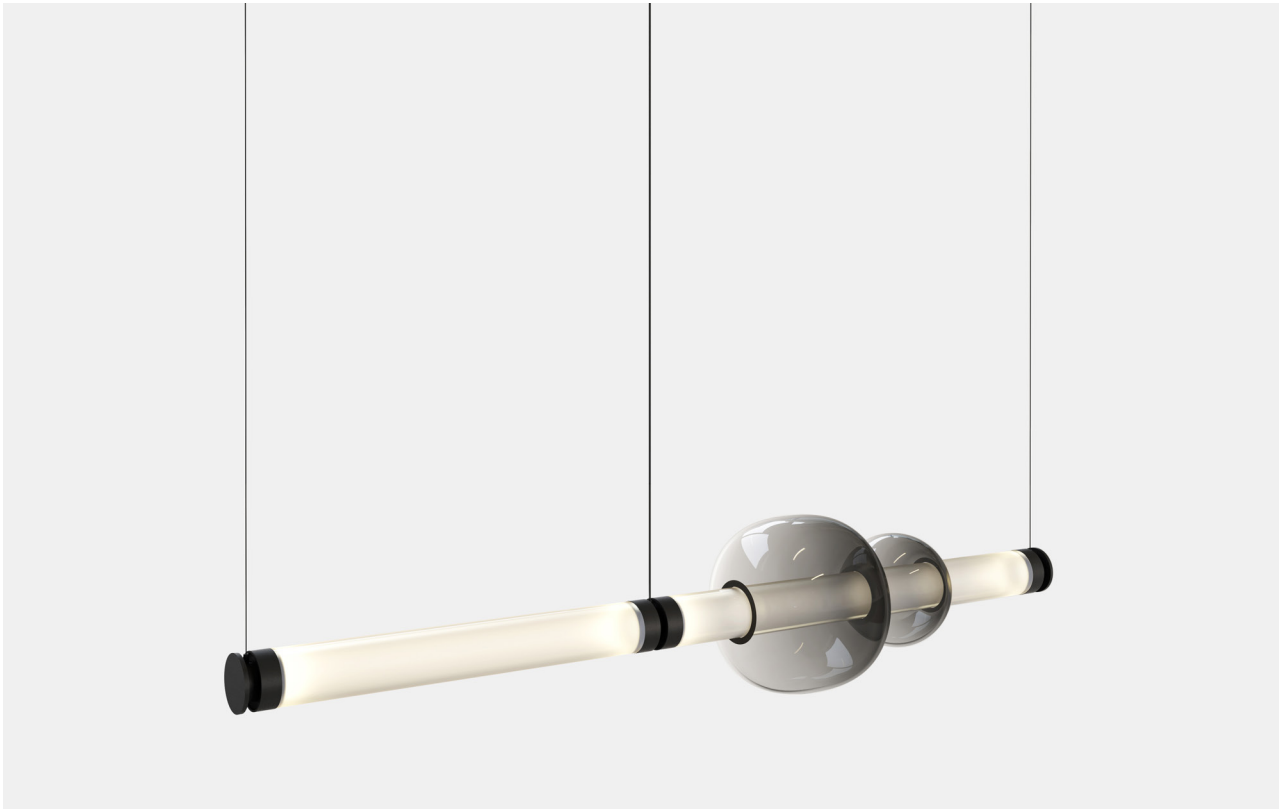

GABRIEL SCOTT

EST. 2012



LUNA
1 Tier Chandelier
Blackened Steel &
Glass Bead Set

A lighting system with infinite interpretations, the Luna is a synergy of color, shape, and refracted light. Inspired by a lunar halo, the modular light fixture grows in every direction as its assembly system stems horizontally or vertically, stacking color upon color of various blowingglass shapes.

The Luna series is a glamorous reference to the moon's diffused light and soft glow. Allusive yet glamorous, the LUNA is a new tradition in glass-work and light form. Available in a variety of colors and shapes, Luna is a highly customizable fixture.

All Gabriel Scott pieces are handmade in Canada.

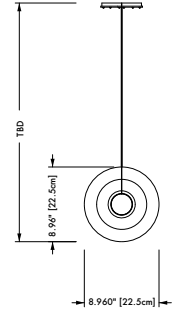
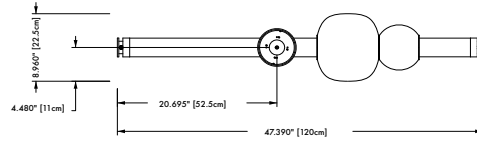
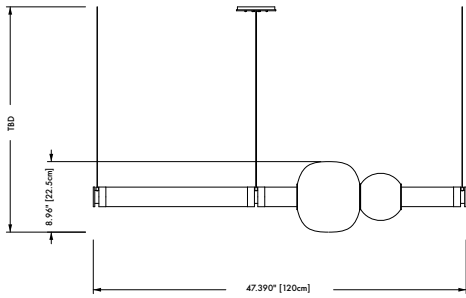

SPECIFICATIONS

Standard Finishes:

Metal: Blackened Steel, Satin Brass, Satin Copper, Satin Bronze or Satin Nickel

Glass Beads: Smoked Amethyst, Smoked Bronze, Smoked Gray, Yellow Glass, Blue Glass or California Pink

Glass Tube: Alabaster White

Specifications:

Dimensions: 47.39" x 8.96" x 8.96" + Drop

120 cm x 23 cm x 23cm + Drop

Weight: 70 lbs / 31.7 kg

Light Source: 24V 6 Watt LED (included)

LED Drivers: E96R24DC - 110V
UVC24100TD - 220V

Standard Lead time: 12 - 14 weeks

Cables & Canopies:

Cable Length: 96" / 244 cm Drop, adjustable upon installation

(increased cable-lengths available upon request)

Standard Canopy: 5" x 0.5" / 12 cm x 1.3 cm

Deep Canopy: Dimensions on request.

Custom finishes available upon inquiry.

Made and assembled in Canada. Item is UL & CE listed.



STANDARD FINISHES

Metal:

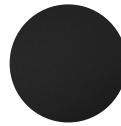

Blackened Steel



Satin Brass



Satin Copper



Satin Bronze



Satin Nickel

Glass Beads:



Smoked Amethyst



Smoked Bronze



Smoked Gray



Yellow Glass



Blue Glass



California Pink

Glass Tube:



Alabaster White

LED DRIVER

E96R24DC - 110V

Magnitude's E96R24DC dimmable voltage LED driver is class 2 rated and designed to operate with any standard MLV/ Incandescent TRIAC (Leading edge) dimmer switch. The driver's low profile aluminum case makes it the perfect choice for under cabinet lights, tape lights and various LED fixtures installations. Our electrical specification includes Auto Reset, over current and short circuit protection. Efficiency of 90% and higher allows the driver to operate at low temperatures.

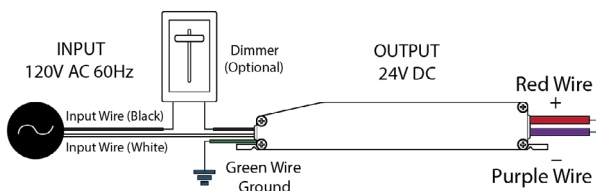
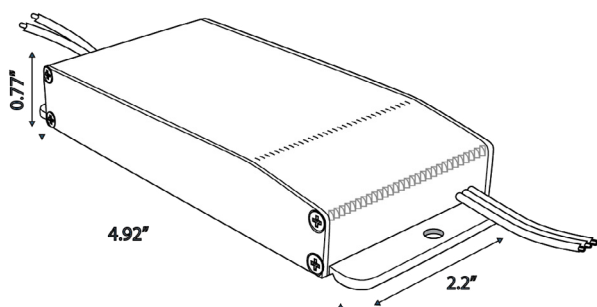

Features:

- Dimmable with any standard MLV/Incandescent TRIAC- (Leading edge) dimmer switch
- Dim down to 1%
- Super compact ALUMINUM CASE.
- Class 2
- UL 8750
- IP67 - Withstands wet and salty conditions.
- Auto-Reset Protection for short circuits & over-voltage.
- FCC 15 part 2

Specifications:

Max Load	96W
Input Voltage	120V AC
Input Current at Max Load	1 A
Output Voltage	24V DC
Output Current at Max load	4 A
Power Factor	0.95
Efficiency	> 90 %
Operating Temp.	-30c - 50c (-22F -122F)
Short Circuit Protection	Yes
Overcurrent Protection	Yes
Over Temperature	Yes
Open Circuit Protections	Yes
Input Wires (White / Black)	18 AWG
Output Wires (Red / Black)	14 AWG
Weight	255g
Dimensions (inches)	4.92" x 2.2" x 0.77"
Dimensions (cm)	12.5 cm x 5.6 cm x 2 cm

LED DRIVER

UVC24100TD - 220V

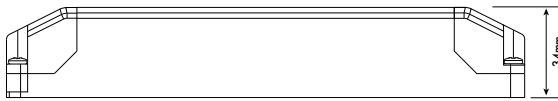
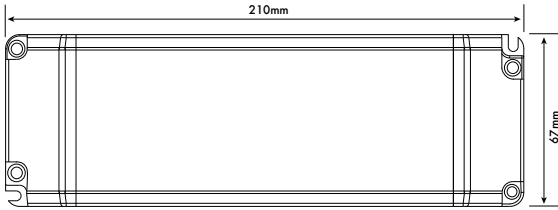

Features:

- Constant voltage output
- Fully isolated
- Short circuit, over current and over voltage protection up to 80% efficient.
- Fire resistant plastic cover
- Compatible with leading and trailing edge dimmers
- 34 - 100% Dimming Load
- 1 - 100% Dimming range
- Mains dimmable
- Screw terminals
- IP20 design for indoor use
- 2 years warranty

Specifications:

Part Code	UVC24100TD
Voltage	220V - 240VAC
Frequency	50-60 Hz
Current	0.6A
Inrush Current	<65A
Power Factor	0.95
Load Voltage	24V
No Load Voltage	24V
Current	1.4 ~ 4.2A
Power	34 ~100W
Power Factor	>0.95
Efficiency (TYP)	>89%
Over Load	Auto-recovery
Short Circuit	Auto-recovery
Over Voltage	Auto-recovery
Operating Temperature	-20 ~ +50°C
Storage Temperature	-40 ~ +70°C
Relative Humidity	5 ~ 95%
Lifetime	50K hrs at TC max (85°C)
Connections	Screw terminal on I/P & O/P
Weight	360g
Dimensions (inches)	8.3" x 2.6" x 1.3"
Dimensions (cm)	21 cm x 6.7 cm x 3.4 cm