



GABRIEL SCOTT

EST. 2012



KELLY
X-Large Chandelier
in Satin Brass

A chandelier that moves with glamorous intrigue, the Kelly Chandeliers metallic chain cascades through its various layers to create a glisten reflective effect. A bold synergy of cold metal with warm light, the black or brass frame hosts a matching chain that brightens any interior with midnight color.

With its Art Deco sensibility, the Kelly Chandelier is a transitional light fixture of exemplary proportion. Available in small, large and x-large.

All Gabriel Scott pieces are handmade in Canada.

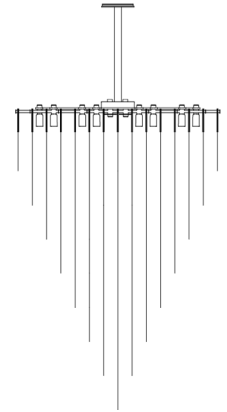
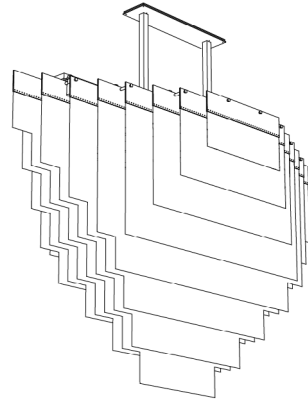
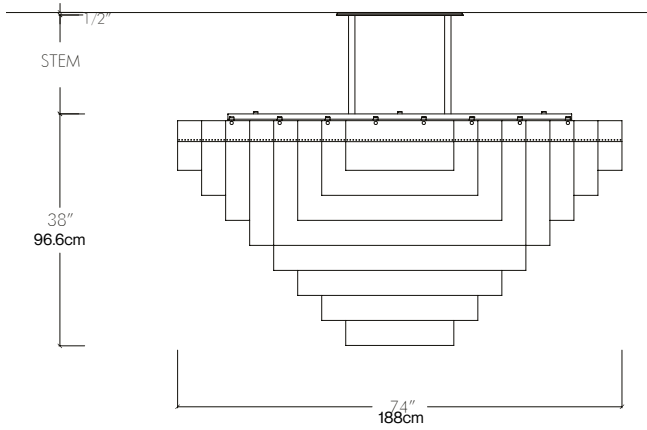

SPECIFICATIONS

Standard Finishes:

Metal: Blackened Steel or Satin Brass

Specifications:

Dimensions: 74" x 32" x 38" H + Stem

188 cm x 81 cm x 97 cm H + Stem

Weight: 215 lbs / 97.5 kg

Light Source: 12V 3 Watt LED bulb (included)

LED Drivers: E60L12DC-KO - 110V
UVC1250TD - 220V

Standard Lead time: 12 - 14 weeks

Stems & Canopies:

Standard Stem Lengths: 6", 12", 18" or 24"

15 cm, 31 cm, 46 cm or 61 cm

Additional Stem Lengths: 30", 36", 42" or 48"

76 cm, 91 cm, 107 cm or 122 cm
(up-charge applies)

Standard Canopy: 5" x 0.5" / 12 cm x 1.3 cm

Deep Canopy: Dimensions on request.

Custom finishes available upon inquiry.

Made and assembled in Canada. Item is UL & CE listed.

STANDARD FINISHES

Metal:

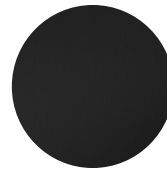

Blackened Steel



Satin Brass

LED DRIVER

E60L12DC-KO - 110V

Magnitude's E60L12DC-KO dimmable voltage LED driver is class 2 rated and designed to operate with any standard MLV/ Incandescent TRIAC (Leading edge) dimmer switch. Encased in a low profile aluminum enclosure that includes 2 knock-outs to enable easy installation makes it the perfect choice for under cabinet lights, tape lights and various LED fixtures installations. Our electrical specification includes Auto Reset, over current and short circuit protection. Efficiency of 90% and higher allows the driver to operate at low temperatures.

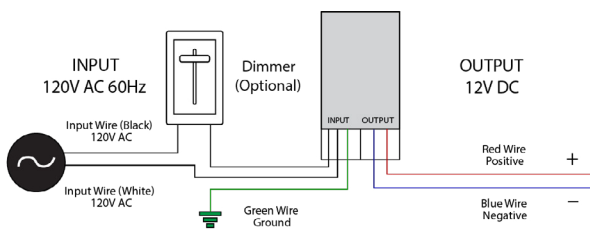
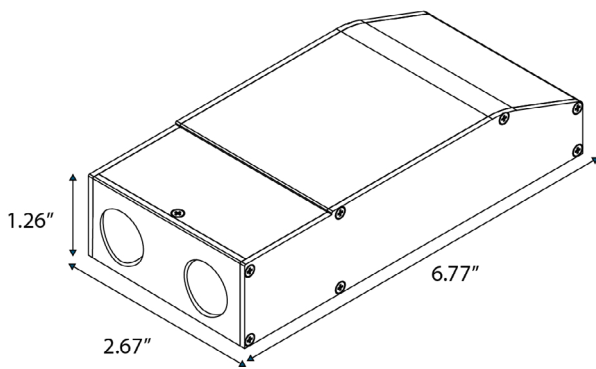

Features:

- Dimmable with any standard MLV/Incandescent TRI-AC- (Leading edge) dimmer switch.
- Super compact ALUMINUM CASE.
- Class 2
- UL 8750
- IP67 - Withstands wet and salty conditions.
- Nema 3R - Outdoor Use
- Auto-Reset Protection for short circuits & over-voltage.
- FCC 15 part 2
- 12V DC True RMS

Specifications:

| | |
|-----------------------------|---------------------------|
| Max Load | 60W |
| Input Voltage | 120V AC |
| Input Current at Max Load | 0.61 A |
| Output Voltage | 12V DC |
| Output Current at Max load | 5.26 A |
| Power Factor | 0.95 |
| Efficiency | > 90 % |
| Operating Temp. | -20c - 70c (-4F -158F) |
| Short Circuit Protection | Yes |
| Overcurrent Protection | Yes |
| Over Temperature | Yes |
| Open Circuit Protections | Yes |
| Input Wires (White / Black) | 14 AWG |
| Output Wires (Red / Black) | 18 AWG |
| Weight | 481g |
| Dimensions (inches) | 6.77" x 2.67" x 1.26" |
| Dimensions (cm) | 17.2 cm x 6.8 cm x 3.2 cm |

LED DRIVER

UVC1250TD - 220V

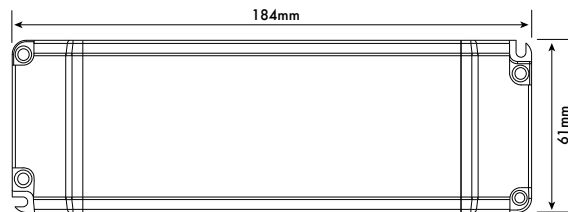

Features:

- Constant voltage output
- Fully isolated
- Short circuit, over current and over voltage protection up to 80% efficient.
- Fire resistant plastic cover
- Compatible with leading and trailing edge dimmers
- 20 ~ 100% Dimming Load and Dimming range
- Mains dimmable
- Screw terminals
- IP44 design for indoor use
- 2 years warranty

Specifications:

| | |
|-----------------------|-----------------------------|
| Part Code | UVC1250TD UVC2450TD |
| Voltage | 220V ~ 240VAC |
| Frequency | 50-60 Hz |
| Current | 0.4A |
| Inrush Current | <2.5A |
| Power Factor | 0.95 |
| Load Voltage | 12V |
| No Load Voltage | 12V |
| Current | 4.16A |
| Power | 50W |
| Power Factor | >0.95 |
| Efficiency (TYP) | >80% |
| Over Load | Auto-recovery |
| Short Circuit | Auto-recovery |
| Over Voltage | Auto-recovery |
| Operating Temperature | -20 ~ +50°C |
| Storage Temperature | -40 ~ +70°C |
| Relative Humidity | 5 ~ 95% |
| Lifetime | 50K hrs at TC max (85°C) |
| Connections | Screw terminal on I/P & O/P |
| Weight | 200g |
| Dimensions (inches) | 7.2" x 2.4" x 1.25" |
| Dimensions (cm) | 18.4 cm x 6 cm x 3.2 cm |