

W CHAIRS

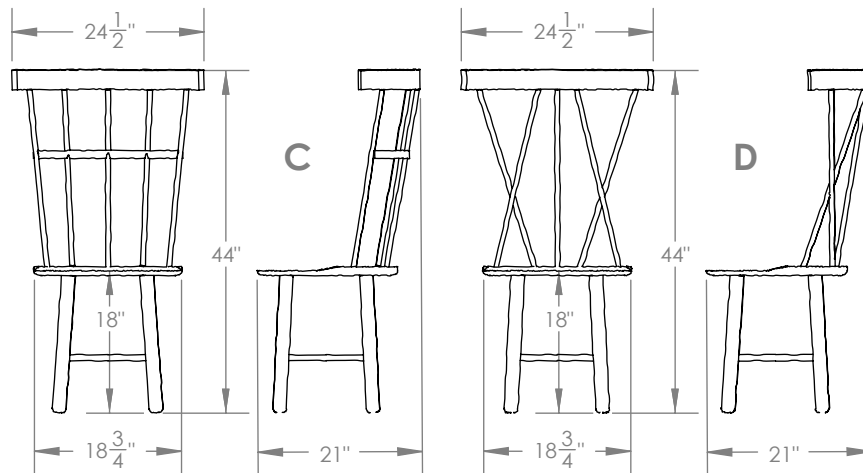
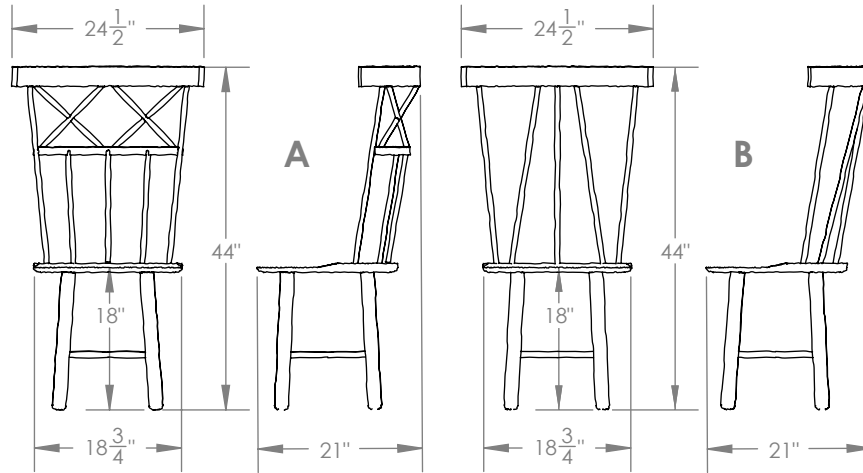

A modern interpretation of the classic Windsor chair. Made from hard maple, each spoke and leg is meticulously hand-carved with soft organic contours.

Materials
Hard Maple

Standard Finishes
Ebony Stain
Clear Satin Oil

Dimensions
24-1/2" W x 44" H x 21" D

Notes

Retail
\$7,500

Lead Time
18-20 Weeks

Customization Available - please contact us. **Weight** ~9 lbs