

FINDINGS LIGHT

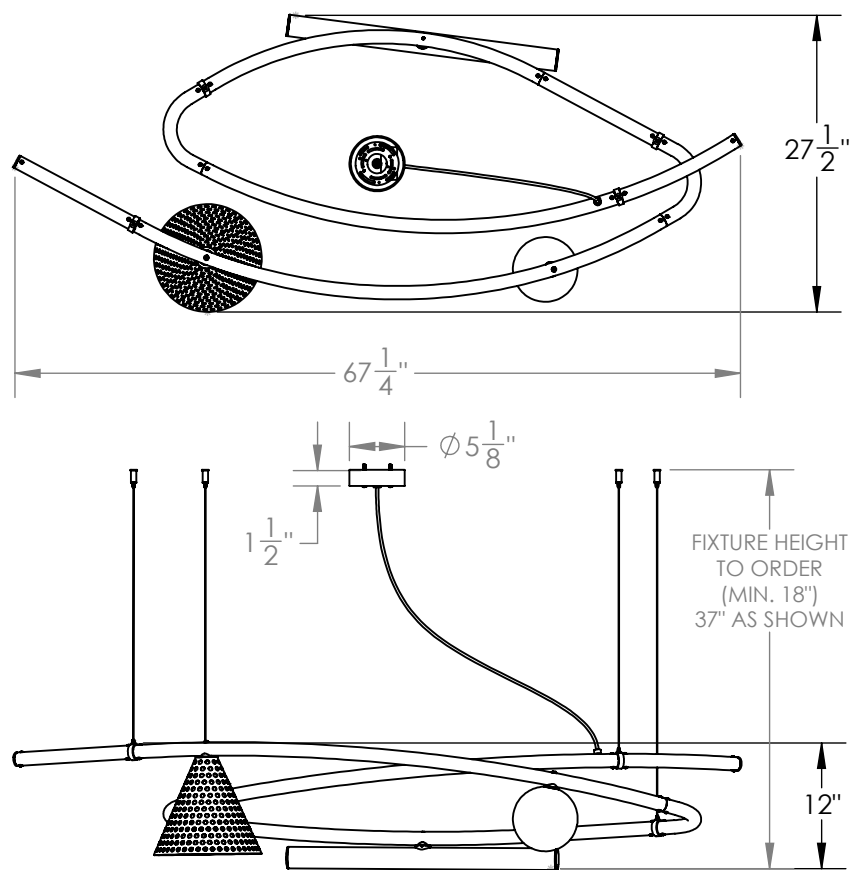

A collection of lit forms hang from a bronze patinated metal armature. A perfect cylinder sits alongside a handblown glass orb and a glass teardrop within a perforated metal shade.

Materials

Glass
Brass
Steel
Aluminum
Acrylic

Standard Finishes

White Glossy Glass
Sulfur Bronze
Frosted Acrylic

Dimensions

67-1/4" W x 12" H x 27-1/2" D
Overall height to order - minimum 18"

Notes

Lamping: Tube - 12VDC LED strip, 9W, 1100 lumens, 3000K color temperature. Globe + Cone - 12VDC G4 LED bulbs, 5W, 450 lumens, 3000K color temperature.
120V/240VAC-to-12VDC transformer included.
This product is not come UL Certified. Should you need UL Certification, please inquire.

Retail

\$14,500

Lead Time

10-12 Weeks

Customization Available - please contact us. **Weight** ~20 lbs